



LADESYSTEM HOCHFREQUENZ-TECHNOLOGIE

Instruction Manual

Revision no.: ENG-0008

ENG

FILON FUTUR L
FILON FUTUR XL



Preamble

Notes regarding this instruction manual

This ORIGINAL INSTRUCTION MANUAL provides the knowledge required for the safe operation of the battery charger. All information is described in a short and clear manner. Chapters and pages are numbered continuously.

This instruction manual documents the Filon Futur L & XL battery charger types. The corresponding data is listed in the appendix "Technical data". Ensure that the appropriate description of the available battery charger is used during operation and performance of maintenance work.

Our battery chargers are subject to continuous further development. Please understand that we have to reserve the right to make changes in form, features and technology. Thus, no claims can be derived from the information contained in this instruction manual regarding specific characteristics of the battery charger.

Copyright

The copyright remains with the company
Industrie Elektronik Brilon GmbH.

Industrie Elektronik Brilon GmbH

Almerfeldweg 40
59929 Brilon, Germany

Ph.: +49 2961/9607-0
Fax: +49 2961/9607-77

www.ieb.de – info@ieb.de

Contents

- 1. General information..... 6**
- 1.1 Purpose of the instruction manual 6

- 2. Safety 7**
- 2.1 General information 7
- 2.2 Information regarding signs and symbols 8
- 2.3 Personnel qualification..... 9
- 2.3.1 Commercial use..... 9
- 2.4 Intended use..... 10
- 2.5 Safety instructions regarding troubleshooting, maintenance and repair 12

- 3. Product information..... 13**
- 3.1 Description of the product and its function..... 13
- 3.2 Type designation 13
- 3.3 Description of the accessories and their function 14
- 3.3.1 Charging plug 14
- 3.4 Residual risk..... 14
- 3.5 Description of the safety devices 16
- 3.6 Markings and signs on the charger..... 17
- 3.6.1 Type plate (example)..... 17
- 3.6.2 QR code (example)..... 17

- 4. Assembly and commissioning..... 18**
- 4.1 Safety instructions regarding assembly and installation 18
- 4.2 Scope of delivery 19
- 4.3 Requirements regarding the place of use 19
- 4.4 Assembly / Installation of the charger and placing the battery 20
- 4.5 Mains connection and fuses 22
- 4.6 Cable holder 22
- 4.7 Connecting the charger to the supply network..... 23
- 4.8 Initial commissioning and functional test..... 24

- 5. Operation..... 25**
- 5.1 Safety information regarding operation..... 25
- 5.2 Visual inspection prior to commissioning 26
- 5.3 Activities prior to charging..... 27
- 5.4 Description of the operating and display unit 28
- 5.4.1 Meaning of the pause button 28
- 5.4.2 Indication of the operating state via LED display 29
- 5.4.3 Indication of the operating state via graphic display (o) 30
- 5.5 Connecting the charger to the mains 33
- 5.6 Connecting the battery..... 33

5.7 Charging process starts automatically	35
5.8 Manually interrupt the charging process and restart, if necessary	37
5.9 Charging process ends automatically	38
5.9.1 Charge retention	38
5.10 Device options (o)	39
5.10.1 Charging process with electrolyte circulation „EC“ (o)	39
5.10.2 Start-up block (o)	39
5.10.3 Charging process with temperature compensation (o)	39
5.10.4 External charging indicator (traffic light display) (o)	40
5.10.5 IP44 and IP54 housing (o)	40
5.10.6 Dust filter and droplet separator (o)	40
5.10.7 Wide Range (o)	41
5.10.8 Aquamatik (o)	41
5.11 Faults and error messages	42
5.12 Warnings	46
5.13 Disconnect the charger from the supply network	46
6. Maintenance and repair	47
6.1 Cleaning, inspection and maintenance	47
6.2 Spare parts	48
7. Disposal	49
8. Appendix	50
8.1 Dimension and section drawing	50
9. Technical data - Standards	52

1. General information

1.1 Purpose of the instruction manual

Purpose of this instruction manual is to enable the intended use and safe operation of the FILON FUTUR L & XL battery chargers (hereinafter referred to as “charger”).

Always keep the instruction manual in an easily accessible location near the charger. Any person assigned with the operation of the charger (which involves transport, assembly and installation, operation, maintenance and disassembly) must read and apply the instruction manual.

In addition to the instruction manual, all mandatory directives, standards and laws for safe and proper working in the country and place of use must be observed, when the charger is used for commercial purposes.

Further information in addition to this manual can be provided by the experts of the manufacturer and/or supplier.

All documents are protected by copyright laws. The documents and their contents shall not be reproduced or transferred in any form without express permission.

2. Safety

2.1 General information

The instruction manual is an integral part of the charger.

The operator has to ensure that the instruction manual is available near the charger at any time and that the operating personnel are made aware of the directives mentioned in this manual.

The instruction manual is to be supplemented by the operator regarding the instructions due to national regulations for accident prevention and environmental protection, including the information on the responsibilities of supervision and obligations to report for the observance of operational specifics, e.g. concerning labour organisations, operational sequences and appointed personnel.

In addition to the instruction manual and to the mandatory regulations for accident prevention in the country and place of use, the generally recognised technical rules for safe and proper working must also be observed.

2.2 Information regarding signs and symbols

The charger is manufactured according to the generally recognised rules and current state of the art. To provide sufficient security for the personnel, additional safety instructions are given. A secure handling of the charger can only be guaranteed if these instructions are followed.

Safety instructions and markings

Safety instructions and important explanations are marked with the following pictograms:

! Danger

Indicates an extremely dangerous situation. Failure to comply with these instructions could result in severe irreversible injuries or death.

! Warning

Indicates an extremely dangerous situation. Failure to comply with these instructions could result in severe irreversible injuries or death.

! Caution

Indicates a dangerous situation. Failure to comply with these instructions could result in minor or moderate injuries.

Note

Indicates a risk of damage to goods. Failure to comply with these instructions could result in property damage.

- ➔ Placed in front of notes and explanations
- Marks standard equipment
- Marks standard equipment

2.3 Personnel qualification

The charger must only be operated by qualified personnel. The responsibilities of the personnel regarding operation, installation and repair must be clearly defined.

! Warning

Warning of dangerous electrical voltage!

The charger is an electrical device containing voltages and currents which are harmful to humans.

- ▶ The charger may only be operated by qualified personnel that have been instructed and trained.
 - ▶ Disconnect the power supply and, if necessary, the connection to the battery, before opening and working on the charger.
 - ▶ Only qualified electricians may open and repair the charger.
-

Qualified personnel according to these general instructions are persons who are familiar with:

- the assembly and installation,
- the commissioning,
- the operation,
- the decommissioning and disassembly

and who have the appropriate qualifications.

Maintenance and repair work on the charger may only be performed by qualified and authorised electricians.

The manufacturer will not be liable for damages and malfunctions resulting from non-compliance with the instruction manual.

2.3.1 Commercial use

If the charger is used for commercial purposes, the following applies additionally:

- Through special training and instruction, the operator must be familiar with the charging process of the particular batteries and their handling.
- Only assigned personnel may operate the charger.

2.4 Intended use

The charger is intended only for the charging of rechargeable batteries. Depending on the preset charging program, you may only charge the batteries which match the charging program. The charger is not suitable for non-rechargeable batteries!

Depending on the operator's requirements, the charger can be equipped with several charging plugs. The operator is obliged to

- use only charging plugs which are specified for the device's charging current and battery voltage
 - exclude the wrong connection of improper battery types.
- ➔ The latter can be carried out, for example, by a colour or mechanical coding of the charging plug.

Note

The instructions of the battery manufacturer must be observed and complied with!

! Caution

If a charger has subsequently been equipped with a modified charging program, the operator is obliged to attach a permanent marking to the housing of the device which informs about the appropriate battery type.

! Danger

There is a risk of explosion when charging inappropriate or incorrectly set battery types

It is not permitted to charge a battery that has not been approved for this charger. Furthermore, the charging program set in the charger must match the battery type to be charged. Failure to comply with the above mentioned instructions could result in damages to the charger and battery. The battery could produce an excess of gas, boil or even explode!

- ▶ Always ensure that the charger is set for the appropriate battery type. In case of doubt, contact the responsible qualified personnel.
-

With regard to the intended use, the data

- concerning the place of use (refer to sections “Safety instructions regarding assembly and installation” and “Requirements regarding the place of use”),
- concerning the type plate (refer to section “Markings and signs on the charger”)
- contained in the technical data (refer to appendix “Technical data”)

must be observed and complied with.

! Danger

There is a risk of severe personal injuries and property damage resulting from:

- ▶ improper use or incorrect operation,
- ▶ unauthorised opening of the charger,
- ▶ wrong installation or improper maintenance and repair.

! Danger

Any information contained in this instruction manual regarding the intended use, residual risk (refer to section “Residual risk”), installation, operation as well as maintenance and repair must be observed and complied with.

The charger may only be used according to the applications specified in the instruction manual and technical description. It may only be operated with accessories and/or components which have been approved or recommended by the manufacturer.

Any other use is considered to be improper. The operator and/or user of the charger shall be solely liable for any damages resulting from non-compliance.

Commissioning of the charger is only permitted, if the guidelines on electromagnetic compatibility (2004/108/CE) are complied with.

2.5 Safety instructions regarding troubleshooting, maintenance and repair

Before carrying out maintenance or repair work, the charger must be disconnected from the supply voltage and battery.

Do not open the housing of the charger until it has been disconnected from the supply network and battery for 5 minutes. Thus, the built-in condensers are given a chance to run down.

No alterations, additions and modifications which could affect safety may be made to the charger without permission of the manufacturer! This also applies to the installation and adjustment of safety devices. Particular care must be taken to ensure that distances and clearances are not reduced.

Used spare parts have to comply with the technical requirements determined by the manufacturer. This is always guaranteed with original spare parts.

3. Product information

3.1 Description of the product and its function

The charger is exclusively intended for charging batteries. Depending on the preset charging program, only the respective batteries may be charged.

The charger includes the following:

- at least one controllable, high frequency clocked power unit,
- microprocessor controlled charging electronics,
- an operating and display unit with pause button (depending on the model with five luminous elements (LED) or optionally with five luminous elements and graphic display).

The customer-specific charging program for the respective battery type is preset at the factory. The individual components of the charger are installed in a stable steel sheet housing. The charger is connected to the mains via a power cable and plug.

Charging cables can be equipped with a battery-specific charging plug for the battery connection.

3.2 Type designation

The FILON FUTUR L & XL chargers are available in various designs. An example of an itemised type designation (for a 24V/60A charger) is given below:

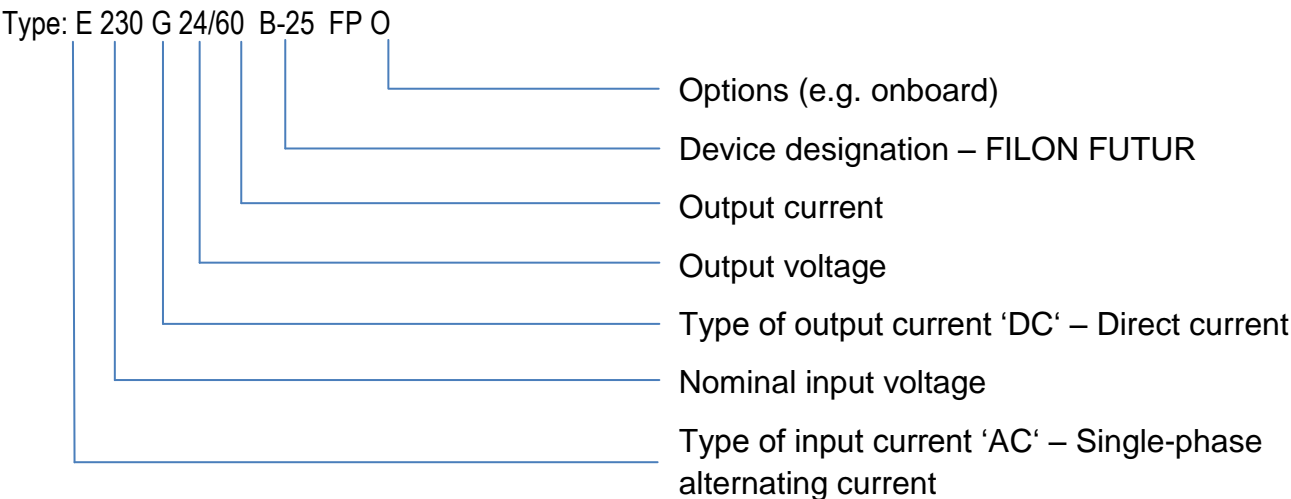

➔ Detailed technical data can be found on the type plate attached to the charger as well as in the appendix (refer to sections “Markings and signs on the charger” and “Technical data”).

3.3 Description of the accessories and their function

3.3.1 Charging plug

Different charging plugs are to be used depending on the battery type. Charging plugs can already be equipped with a battery-specific charging plug for the battery connection. However, this is not always the case. Further technical information is determined in the enclosed delivery documents (and order confirmation).

3.4 Residual risk

! Warning

There is a risk of explosion due to gases which result during charging

During charging, the battery emits a mixture of oxygen and hydrogen (oxyhydrogen). Gassing is a chemical process. This gas mixture is highly explosive and must not be ignited.

- ▶ Connecting and disconnecting the charging cable of the charger to/from the battery plug must only be performed on a switched-off device.
- ▶ The charger has to be adjusted to the battery regarding voltage and charging capacity.
- ▶ Prior to charging, ensure that the cable and plug connections have no visible damages.
- ▶ Ensure adequate ventilation in rooms where batteries are charged.
- ▶ The surfaces of the battery cells have to be exposed during the charging process to ensure adequate ventilation.
- ▶ Do not smoke or use an open flame when handling batteries.
- ▶ Areas where batteries are charged must be free from flammable substances or sparking tools within a distance of at least 2 m.
- ▶ Fire fighting equipment must be provided.
- ▶ Do not place metallic objects onto the battery.
- ▶ Strictly observe the safety regulations (refer to chapter "Safety").

! Warning

Warning of dangerous electrical voltage!

The charger is an electrical device containing voltages and currents which are harmful to humans.

- ▶ The charger may only be operated by qualified personnel that have been instructed and trained.
- ▶ Disconnect the power supply and, if necessary, the connection to the battery, before opening and working on the charger.
- ▶ Only qualified electricians may open and repair the charger.

! Warning

Danger from getting caught in charging cables!

Cables lying around present a risk of tripping. People may get caught in loose cables or trip over them. Furthermore, there is a risk of severe personal injury and property damage, when a running charging process is interrupted by pulling out the charging plug. The generated sparks could ignite the charging gases which result during the charging process and cause a fire or explosion.

- ▶ Place charging cables in such a manner that nobody trips over and/or gets caught in them.
 - ▶ After the charging process has been completed, wind the charging cable and/or place it onto the cable holder (if available).
-

! Danger

There is a risk of explosion when charging inappropriate or incorrectly set battery types

It is not permitted to charge a battery that has not been approved for this charger. Furthermore, the charging program set in the charger must match the battery type to be charged. Failure to comply with the above mentioned instructions could result in damages to the charger and battery. The battery could produce an excess of gas, boil or even explode!

- ▶ Always ensure that the charger is set for the appropriate battery type. In case of doubt, contact the responsible qualified personnel.
-

! Warning

Acid gases might be produced when charging batteries.

Acid gases can cause short circuits (fire hazard) in chargers as well as corrosion of components!

- ▶ Place batteries in front of or next to the charger. Thus, the ascending acid gases are given a chance to freely distribute (dilute) at the place of use and to escape.
-

3.5 Description of the safety devices

The charger has been designed and constructed according to the recognised rules of engineering. When operated according to the intended use, there is no risk to the safety and health of the operating personnel or third parties.

All electrically live components are equipped with housings or coverings which can only be removed with tools. All cables and plugs are properly shielded and/or grounded. The charger is designed according to protection class IP 21 (standard).





All electric and/or electronic components bear the CE marking. The necessary insulation distances are kept. All circuits are secured with primary and secondary fuses with defined current rating and triggering characteristics.

All metallic components are grounded through a protective conductor system.

The charger is equipped with an automatic switch-off which is activated as soon as the preset maximum charge of the battery has been reached. This prevents overcharging as well as an excessive outgassing of explosive vapours.

3.6 Markings and signs on the charger

3.6.1 Type plate (example)

IEB Industrie ELEKTRONIK Brilon 59929 Brilon * Almerfeldweg 40 * Tel.(02961)9607-0					
Typ	E 230 G 24/60 B25-FP				
Batterieladegerät	24 V	Batterieart	PzV		
Geräte-Nr.	660 123456 MMJJ	Ah	480		
Ue	230V ~	Ie N	8,7 A	50/60 Hz	
Ua	24V ⋯	Ia N	60 A	IEBFUT24 60_V109d WE: P_0	
	Pr. T 25A 250V 6,3x32	Sek.	80A Streifensich.		
Achtung: Explosive Gase, Flammen und Funken vermeiden. Während des Ladens für ausreichend Belüftung sorgen. Ladegerät muss im Pause-Modus sein oder ist vom Netz zu trennen, bevor Verbindungen zur Batterie geschlossen oder geöffnet werden.					

The type plate is created for each charger and attached accordingly.

3.6.2 QR code (example)



The QR code is created for each charger and visibly attached. The code can be read with suitable QR scanners. Even modern smartphones can be used for scanning the code if they have the corresponding app (QR code reader).

The following information is contained:

- Device type
- Device number
- Battery type
- Battery capacity
- Charging program – Factory setting
- Contact information IEB GmbH

4. Assembly and commissioning

4.1 Safety instructions regarding assembly and installation

Make sure that no liquids enter the inside of the charger.

The horizontal distance between the charger and flammable materials must be at least 2.5 m. It is not permitted to store flammable materials, e. g. on shelves, or use flammable building materials above the charger. The distance to areas exposed to fire and explosion risks as well as to potentially explosive materials must be at least 5.0 m.

Protect the charger from inadmissible load. Ensure that no components get damaged, particularly during transport and handling. Avoid touching electronic components.

The charger contains electrostatically sensitive components which can easily be damaged due to improper handling. Ensure that electric components are not mechanically damaged or destroyed.

The electrical installation (cable cross-sections, fuse protections, protective conductor connection) must be carried out in accordance with the relevant regulations.

Prior to the electrical installation, compare the performance data mentioned on the type plate with the performance data of the supply connections. Observe the power supply data stated on the type plate (voltage and frequency).

➔ Refer to section "Connecting the charger to the power supply".

4.2 Scope of delivery

Note

Before commencing installation, compare the scope of delivery with the delivery documents to verify completeness. In case of any defects, contact the manufacturer immediately.

Delivery comprises at least the following parts:

- charger with preset charging program,
- connected power and battery cables,
- instruction manual
- and delivery note.

The scope of delivery as well as the charger model may vary depending on the customer requirements. Further technical data can be found in the enclosed delivery documents (as well as in the order confirmation).

Proceeding

- Immediately after delivery, check whether the product has been delivered completely and undamaged.
- Ensure that the data stated on the delivery note matches the data on the type plate.
- In case of defects, immediately contact the manufacturer and, if necessary, the transport company.
- Check, if the charger has unfastened exterior screw connections etc. If necessary, fasten those connections again.

4.3 Requirements regarding the place of use

The charger may only be operated in closed, frost-free and dry rooms. The ambient temperatures at the place of installation may not fall below 0°C and not exceed 40°C.

The place of use may not be subject to excessive dust exposure. Ensure that there are no conductive dusts (soot, metals).

The place of use requires sufficient ventilation so that resulting charging gases (e.g. acid vapours, oxyhydrogen) are given a chance to distribute (dilute) and explosive gas mixtures are securely prevented.

The place of installation has to be selected in such a manner that ventilation openings are not covered and the cooling air is not hindered. Do not place the charger next to radiators or other heat sources. Heat accumulation, caused e. g. through blocked ventilation slots, must be excluded.

4.4 Assembly / Installation of the charger and placing the battery

! Warning

There is a risk of explosion due to gases which result during charging

During charging, the battery emits a mixture of oxygen and hydrogen (oxyhydrogen). Gassing is a chemical process. This gas mixture is highly explosive and must not be ignited.

- ▶ Connecting and disconnecting the charging cable of the charger to/from the battery plug must only be performed on a switched-off device.
- ▶ The charger has to be adjusted to the battery regarding voltage and charging capacity.
- ▶ Prior to charging, ensure that the cable and plug connections have no visible damages.
- ▶ Ensure adequate ventilation in rooms where batteries are charged.
- ▶ The surfaces of the battery cells have to be exposed during the charging process to ensure adequate ventilation.
- ▶ Do not smoke or use an open flame when handling batteries.
- ▶ Areas where batteries are charged must be free from flammable substances or sparking tools within a distance of at least 2,5 m.
- ▶ Fire fighting equipment must be provided.
- ▶ Do not place metallic objects onto the battery.
- ▶ Strictly observe the safety regulations (refer to chapter "Safety").

During the assembly/installation of the charger, the following points are to be observed:
Proceeding

- Use the provided wall fixing material (4 S10 dowels, 4 M6x60 screws) for fixing the charger to the wall. The drilling pattern is enclosed in the appendix (see dimension and section drawing).
- Ensure optimal ventilation of the charger.
- Keep a lateral distance of at least 1.0 m to the next charger. A staggered arrangement of the chargers is necessary, if the distance of at least 1.0 m cannot be kept.
- Keep a distance of at least 0.5 m to adjoining walls.

! Warning

Acid gases might be produced when charging batteries.

Acid gases can cause short circuits (fire hazard) in chargers as well as corrosion of components!

- ▶ Always place batteries next to the charger. Thus, the ascending acid gases are given a chance to freely distribute (dilute) at the place of use and to escape.
-

During the assembly/installation of the charger, ensure that:

- no aggressive gases, e. g. acid gases, are produced,
- there are no conductive dusts, e. g. soot or metal dusts,
- there is no excessively high exposure of non-conductive dusts,
- no liquids enter the inside of the charger.
- Assemble/install the charger in such a manner that the connection to the supply network is within reach of the charger cable (at least 2m).

! Caution

The power cable of the charger must not be extended.

Placing the battery to be charged

Proceeding

- Place the battery in front of or next to the charger, so that the plug of the battery is within reach of the charger's charging cable (standard 2.5 m).

! Caution

The charging cable of the charger must not be extended.

4.5 Mains connection and fuses

! Warning

Warning of dangerous electrical voltage!

- ▶ The charger may only be operated by qualified personnel that have been instructed and trained.
- ▶ Disconnect the power supply and the connection to the battery, before opening and working on the charger.
- ▶ Only qualified electricians may open and repair the charger.

A mains connection is required at the intended place of use for operating the charger. Mains voltage and frequency need to match the data stated on the type plate (refer to section “Markings and signs on the charger”). The mains connection must be properly grounded.

Proceeding

- The upstream fuse needs to be installed according to the following table:

Power supply and mains fuse

Rated current	Mains fuse	Note
0A to 6A	6A gG	gG fuses or automatic circuit breakers with B, C or K characteristic may be used.
>6A to 10A	10A gG	
>10A to 16A	16A gG	
>16A to 18A	20A gG	
>18A to 23A	25A gG	
>23A to 32A	32A gG	

- ➔ Detailed information regarding input and output currents as well as power consumption is stated in the appendix (see “Technical data”).

4.6 Cable holder

The FILON FUTUR L & XL chargers are equipped with a cable holder. The cable holder varies depending on the different housing types.

FILON FUTUR XL cable holder

The cable holder is located on the right side of the housing.

- In case of the HF 550, 650 and 750 housings, the cable holder is attached to the housing from inside by means of a wheel nut.

Proceeding

! Warning

The cable holder (2) of the FILON FUTUR XL charger must only be adjusted by qualified and authorised electricians.

- Loosen the knurled nut (1).
- Move the cable holder (2) downwards.
- Fasten the knurled nut (1) again.

FILON FUTUR L cable holder

The cable holder (2) is located centrally on the rear of the housing.

- In case of the HF450 and HF450 EU housing types, the cable holder (2) is attached to the housing from outside by means of a knurled nut (1).

***Use the cable holder (2) as footstand
(only possible with HF 450 and HF450 EU housing types)***

Proceeding

- Loosen the knurled nut (1).
- Remove the cable holder (2) and attach the knurled nut (1) to the housing again.
- Turn the cable holder (2) and insert it into the opening (3) located on the rear of the housing.

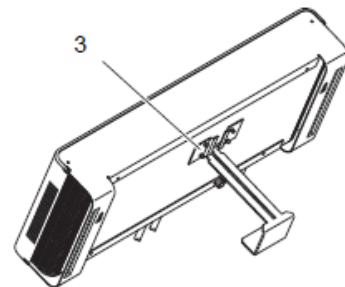

4.7 Connecting the charger to the supply network

Note

Before connecting the charger to the supply network, observe the following sections of chapter “4 Installation and commissioning”:

- ▶ „Safety information regarding assembly and installation“
- ▶ „Assembly / Installation of the charger and placing the battery“
- ▶ „Requirements regarding the place of use“
- ▶ „Mains connection and fuses“

Before connecting the charger, the following conditions need to be fulfilled:

- Assemble/install the charger in such a manner that the connection of the supply network is within reach of the charger cable (at least 2m).

! Caution

The power cable of the charger must not be extended.

- Place the battery in front of or next to the charger, so that the plug of the battery is within reach of the charger's charging cable (standard 2.5 m).

! Warning

Acid gases might be produced when charging batteries.

Acid gases can cause short circuits (fire hazard) in chargers as well as corrosion of components!

- ▶ Place batteries in front of or next to the charger. Thus, the ascending acid gases are given a chance to freely distribute (dilute) at the place of use and to escape.
-

→ Detailed information regarding weights, input and output currents as well as power consumption is stated in the appendix (see "Technical data").

4.8 Initial commissioning and functional test

After the charger has been properly assembled and installed, it needs to be put into operation for the first time in order to perform a functional test (see chapter "Operation").

5. Operation

5.1 Safety information regarding operation

! Warning

Do not use non-rechargeable batteries.

The charger may only be operated in technically perfect condition according to the intended use as well as in a safety and hazard conscious manner in compliance with this instruction manual. In particular, malfunctions that could impair safety must be reported and rectified immediately.

! Warning

A damaged or otherwise defective charger may cause accidents

If the charger and/or its performance show safety-relevant modifications, damages or other defects, do not use the charger until it has been properly repaired.

- ▶ Detected defects must be reported to the superior immediately.
 - ▶ The defective charger must be marked and decommissioned.
 - ▶ Do not use the charger until the defect has been localised and rectified.
-

No liquids must enter the interior of the charger.

The information of the type plate regarding the permissible battery voltage needs to be controlled and maintained (refer to section "Markings and signs on the charger").

The charging cables and battery must be connected with correct polarity.

! Danger

There is a risk of explosion when charging inappropriate or incorrectly set battery types

It is not permitted to charge a battery that has not been approved for this charger. Furthermore, the charging program set in the charger must match the battery type to be charged. Failure to comply with the above mentioned instructions could result in damages to the charger and battery. The battery could produce an excess of gas, boil or even explode!

- ▶ Always ensure that the charger is set for the appropriate battery type. In case of doubt, contact the responsible qualified personnel.
-

! Warning

Danger from getting caught in charging cables!

Cables lying around present a risk of tripping. People may get caught in loose cables or trip over them. Furthermore, there is a risk of severe personal injury and property damage, when a running charging process is interrupted by pulling out the charging plug. The generated sparks could ignite the charging gases which result during the charging process and cause a fire or explosion.

- ▶ Place charging cables in such a manner that nobody trips over and/or gets caught in them.
 - ▶ After the charging process has been completed, wind the charging cable and/or place it onto the cable holder (if available).
-

5.2 Visual inspection prior to commissioning

Prior to each charging, ensure that

- the mains connection is undamaged,
- the housing does not show any damages,
- the insulation of the charging and power cables is undamaged,
- the charging plug is undamaged,
- all exterior screw connections are fastened.

5.3 Activities prior to charging

! Warning

Warning of dangerous electrical voltage!

The charger is an electrical device containing voltages and currents which are harmful to humans.

- ▶ The charger may only be operated by qualified personnel that have been instructed and trained.
 - ▶ Disconnect the power supply and, if necessary, the connection to the battery, before opening and working on the charger.
 - ▶ Only qualified electricians may open and repair the charger.
-

The charging process of a battery normally involves the following steps for the instructed operator:

Proceeding

- Ensure that charger and battery type match,
 - Check the charger for damages (refer to section “Visual inspection prior to commissioning”).
 - Connect the battery to the charger (Connect the charging cable of the charger to the battery connector).
 - Connect the charger to the mains.
 - (Charging process starts automatically, refer to section “Start charging process”).
 - (Charging process ends automatically, refer to section “Charging process ends automatically”).
 - Disconnect the battery from the charger (Disconnect the charging cable of the charger from the battery connector).
- ➔ The following sections provide more detailed information regarding the individual operating steps. These sections must be read carefully prior to the first operation of the charger.

5.4 Description of the operating and display unit

The operating and display unit, which is equipped with five LEDs and a pause button, is located on the front of the charger.

A graphic display can be installed upon customer request.

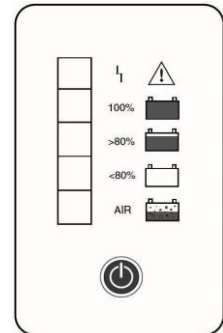













5.4.1 Meaning of the pause button

Depending on the operating state of the charger, the pause button  has different functions:

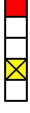
- Interrupt the charging process, refer to section “Manually interrupt the charging process and restart, if necessary”.
- Setting the pause mode, refer to section “Manually interrupt the charging process and restart, if necessary”.

5.4.2 Indication of the operating state via LED display

LED display	Operating state during charging
	No battery
	Fast Charge (o)
	Main charge
	Backup charge
	Main charge with ECS (o)
	Backup charge with ECS (o)
	Charge stop and charge retention for the set battery type
	Cool Down Indikation „CDI“ (o)
	Charging characteristic without charging function (yellow LED flashes)
	Pause mode (LEDs flashing alternately)
	Desulfation
	Desulfation with ECS (o)

5.4.3 Indication of the operating state via graphic display (o)

The operating and display unit, which is equipped with five LEDs and a pause button, is located on the front of the charger. Upon customer request, it can also be equipped with a graphic display which provides visual support for the user. The graphic display has three operating states:

- Start display
- Charging indicator
- Programming mode

Start display

The start display indicates the set charging parameters. This display appears in the following states:

- „No battery“
- Prior to each charging
- After the pause mode has been terminated

Conditions

- Connect the charger to the supply network.



- Battery voltage and charging current
- Set characteristic curve
- Set capacity range
- Set battery type

Charging indicator

The charging indicator displays the current charging parameters. This display is shown during the entire charging process.

Conditions

- The charger is in charge state



- Present battery voltage
- Symbolic battery state
- Bargraph display for charging current (0% - 100%)
- Charging time of the entire charge
- Charged ampere hours
- Present charging current

Formationdisplay

Conditions

- The Charger is in selection state



Batteryvoltage and Chargingcurrent

Formation On / Off

Capacity range

Batterytype

Conditions

- The charger is in Stand by mode



Batteryvoltage and Chargingcurrent

Chargingcurve with aktivated formation

Capacity range

Batterytype

Desulfationdisplay

Conditions

- The Charger is in selection state



Batteryvoltage and Chargingcurrent

Desulfation On / Off

Capacity range

Batterytype

Conditions

- The charger is in Stand by mode



Batteryvoltage and Chargingcurrent

Chargingcurve with aktivated desulfation

Capacity range

Batterytpe

Programming mode

The programming mode indicates the characteristic curves with the set charging parameters.

Conditions

- Connect the charger to the supply network.
- Press and hold the pause button for 10 seconds



Battery voltage and charging current
Set characteristic curve – here shown with EC
characteristic

Set capacity range

Average battery temperature which is compensated
during the charging process

Set battery type

! Warning

The characteristic curve may only be adjusted by instructed and trained personnel.

! Danger

There is a risk of explosion when charging inappropriate or incorrectly set battery types

The charging program set in the charger must match the battery type to be charged. Failure to comply with the above mentioned instructions could result in damages to the charger and battery. The battery could produce an excess of gas, boil or even explode!

- Always ensure that the charger is set for the appropriate battery type. In case of doubt, contact the responsible qualified personnel.

5.5 Connecting the charger to the mains

For the connection to the power supply, the charger is equipped with a power cable with plug.

! Caution

The power cable of the charger must not be extended.

An integral plug for non-heating devices can be installed optionally.

Proceeding

- Connect the charger to the mains by putting the power plug into the wall socket.

5.6 Connecting the battery

! Warning

There is a risk of explosion due to gases which result during charging

During charging, the battery emits a mixture of oxygen and hydrogen (oxyhydrogen). Gassing is a chemical process. This gas mixture is highly explosive and must not be ignited.

- ▶ Connecting and disconnecting the charging cable of the charger to/from the battery plug must only be performed on a switched-off device.
 - ▶ The charger has to be adjusted to the battery regarding voltage and charging capacity.
 - ▶ Prior to charging, ensure that the cable and plug connections have no visible damages.
 - ▶ Ensure adequate ventilation in rooms where batteries are charged.
 - ▶ The surfaces of the battery cells have to be exposed during the charging process to ensure adequate ventilation.
 - ▶ Do not smoke or use an open flame when handling batteries.
 - ▶ Areas where batteries are charged must be free from flammable substances or sparking tools within a distance of at least 2 m.
 - ▶ Fire fighting equipment must be provided.
 - ▶ Do not place metallic objects onto the battery.
 - ▶ Strictly observe the safety regulations (refer to chapter "Safety").
-

! Danger

Risk of acid burns and warning of dangerous electrical voltage

The battery contains sulphuric acid which is highly corrosive. The exposed metal parts of a battery always carry voltage.

- ▶ Do not open the battery housing and do not touch exposed metal parts!
 - ▶ Works on and/or with batteries or battery installations must only be performed by qualified personnel and in compliance with the instruction manual of the battery manufacturer.
-

! Warning

Acid gases might be produced when charging batteries.

Acid gases can cause short circuits (fire hazard) in chargers as well as corrosion of components!

- ▶ Place batteries in front of or next to the charger. Thus, the ascending acid gases are given a chance to freely distribute (dilute) at the place of use and to escape.
-

! Danger

There is a risk of explosion when charging inappropriate or incorrectly set battery types

It is not permitted to charge a battery that has not been approved for this charger. Furthermore, the charging program set in the charger must match the battery type to be charged. Failure to comply with the above mentioned instructions could result in damages to the charger and battery. The battery could produce an excess of gas, boil or even explode!

- ▶ Always ensure that the charger is set for the appropriate battery type. In case of doubt, contact the responsible qualified personnel.
-

! Warning

Danger from getting caught in charging cables!

Cables lying around present a risk of tripping. People may get caught in loose cables or trip over them. Furthermore, there is a risk of severe personal injury and property damage, when a running charging process is interrupted by pulling out the charging plug. The generated sparks could ignite the charging gases which result during the charging process and cause a fire or explosion.

- ▶ Place charging cables in such a manner that nobody trips over and/or gets caught in them.
 - ▶ After the charging process has been completed, wind the charging cable and/or place it onto the cable holder (if available).
-

Connecting the battery to the charger

Conditions

- The charger is not connected to the supply network.

Proceeding

- Place charging cables in such a manner that nobody trips over them and thereby interrupts the charging process.
- Insert the charging plug of the charger into the battery connector.

5.7 Charging process starts

5.7.1 Charging process starts automatically

Conditions

- The characteristic curve with charging function is set in the charger
- The battery voltage is at least 0.5 V/Z
- The battery voltage is lower than 2.4 V/Z

The battery voltage is lower than 2.4 V/Z

- Connect the battery to the charger
- Do not press the pause button.
- Connect the charger to the supply network.

The charger switches on automatically after it has been connected to the supply network for 5 seconds. Depending on the battery's state of charge, either the green LED (100%) or one of the yellow LEDs (>80% / <80%) lights up.

- ➔ If the battery voltage is lower than 1.9 V/Z, the yellow LED "<80%" (battery deeply discharged) flashes. When the battery voltage is lower than 1.5 V/Z, the yellow LED "<80%" (battery deeply discharged) flashes and the charging current is limited to 10% of the rated current. If this process continues for more than 30 minutes, the charger switches off with an error message (the red and yellow (main charge) LEDs are lit).

5.7.2 Charging process starts with desulfation or formation characteristic

The formation and desulfation can be activated, depending on the type of battery (see characteristics table). Were the desulfation / formation completed correctly, the charger automatically switches back to the default setting of the respective characteristic.

Desulfation:

The Desulfation characteristic is used for desulfated batteries, to reduce the sulfate layer. The battery is charged 21 hours with a constant current (3A/100Ah).

Formation:

The Formation characteristic is used for new batteries. The battery is charged during the first three charge cycles with an increased load factor (1.3).



Conditions

- Characteristic with charging function is set in the charger
- Battery voltage is at least 0.5 V / C
- Battery voltage below 2.4 V / C
- The charger is in:
 - Stand-by mode
 - In the initial phase of the load (5 seconds before the start of charging)

Proceeding

- Press pause button
- In the selection menu, select and activate the desired service characteristic by pressing the pause button

Display

LED - Display	Description
	<p style="text-align: center;">Desulfation (o)</p> <p>Disabled: the LED flash 1 time per second Enabled: the LED flash 3 times per second</p>
	<p style="text-align: center;">Formation (o)</p> <p>Disabled: the LED flash 1 time per second Enabled: the LED flash 3 times per second</p>

5.8 Manually interrupt the charging process and restart, if necessary

! Warning

Explosion hazard!

There is a risk of severe personal injury and property damage, when the battery is disconnected during a running charging process. The generated sparks could ignite the charging gases which result during the charging process.

- ▶ Press the pause button in order to interrupt the charging process. Afterwards, disconnect the charger from the supply network. Then disconnect the charging cable from the charger and finally the battery plug.

Note

During normal operation, the charging process must not be interrupted prior to the automatic switch-off. Early interrupting may lead to an insufficient charge state. The available battery capacity is thereby reduced.

Interrupt the charging process and restart, if necessary

Conditions

- The charger is switched on
- The battery is connected to the charger.

Proceeding

- Press the pause button for less than 1 second. The charging process is interrupted and the charger switches to the pause mode. The green LED "100%" and yellow LED "<80%" flash alternately.
- ➔ If the state of the charger remains unchanged, the charging process continues automatically after 1 minute. Depending on the battery's state of charge, either the green LED (100%) or one of the yellow LEDs (">80%" / "< 80%") lights up.
- Press the pause button again for less than 1 second. The charging process continues. Depending on the battery's state of charge, either the green LED (100%) or one of the yellow LEDs (">80%" / "< 80%") lights up.
- Press the ON/OFF button for more than 3 seconds. The charger will be restarted after 15 seconds.

5.9 Charging process ends automatically

The charging process ends automatically as soon as the battery is fully charged. The battery can be used again.

The green LED "100%" indicates the charge stop as well as the charge retention.

5.9.1 Charge retention

As long as the battery is not disconnected from the charger, the specified charge retention for the set battery proceeds.

Description of the charge retention

Conditions

- The charging program has been completed
- The battery is fully charged
- The green LED "100%" lights up and indicates the charge stop and/or charge retention.

Proceeding

The charger performs the specified charging compensation for the respectively set battery.

5.10 Device options (o)

5.10.1 Charging process with electrolyte circulation „EC“ (o)

Note

If the EC pump is switched on, the blue LED „AIR“ on the operating and display unit is lit. The proper operation of the electrolyte circulation (EC) is monitored with a potential-free pressure switch in the pump housing.

If the charger detects a pressure drop during charging, the charging process will be continued with the charge factor 1.20. The blue LED „AIR“ on the operating and display unit flashes. The respective operating state remains lit.

The battery will be charged with the original charge factor, if the pressure drop has been rectified within the first hour.

- ▶ The EC pump must not be operated without counter-pressure.
- ▶ Install the charger in such a manner that the built-in EC pump is placed at a distance of at least 0.5 m over the battery to be charged.
- ▶ If an error message occurs (blue LED „AIR“ flashes), fully charge the battery without electrolyte circulation. Early interrupting may lead to an insufficient charge state. The available battery capacity is thereby reduced.

A restart is only performed after the battery has been disconnected.

5.10.2 Start-up block (o)

Onboard devices are equipped with a start-up lock. Here, the charger is connected to the automotive electronics. The electric vehicle is disabled as long as the charger is connected to the supply voltage. The start-up block is a potential-free alternating contact (max. 42V 5A), which is conducted on a three-pole terminal strip.

! Warning

Warning of dangerous electrical voltage!

There is a risk of serious damage or injury, if the start-up block is wired improper.

5.10.3 Charging process with temperature compensation (o)

The temperature compensation adjusts the charging voltage (U1) to the measured battery temperature by means of an external temperature sensor.

If the maximal temperatures of the batteries are exceeded, the charger reports an error (see section 5.11 „Faults and error messages“) and interrupts charging. Depending on the used battery type, the set maximum temperatures vary as follows:

- Wet cell battery: 60°C
- Gel battery: 50°C

If the charger cannot establish a connection to the temperature sensor, a warning message is issued (see section 5.12 „Warnings“) and charging proceeds.

5.10.4 External charging indicator (traffic light display) (o)

For a better and quicker visibility of the charging state from a larger distance, an external traffic light display with 360° allround signalling can be connected to the charger. The display is identical with the LED display of the charger.

5.10.5 IP44 and IP54 housing (o)

Chargers with IP44/54 housings are equipped with dust filters, which are attached to the housing.

Note

To ensure flawless operation of the chargers, these have to be cleaned at regular intervals:

- ▶ Check the dust filters for dirt monthly and clean or replace them, if necessary.

Polluted dust filters can be cleaned with compressed air. If this is no longer possible due to extreme pollution or wear, the filters have to be replaced.

The inspection intervals may need to be adjusted to the local conditions, e. g. if the dust generation is strongly increased.

These works may only be carried out by qualified personnel.

5.10.6 Dust filter and droplet separator (o)

The FILON FUTUR L and FILON FUTUR XL chargers can be equipped with a dust filter or droplet separator.

Note

To ensure flawless operation of the chargers, these have to be cleaned at regular intervals:

- ▶ Check dust filters and droplet separators for dirt monthly and clean or replace them, if necessary.

Polluted dust filters can be cleaned with compressed air. If this is no longer possible due to extreme pollution or wear, the filters have to be replaced.

The inspection intervals may need to be adjusted to the local conditions, e. g. if the dust generation is strongly increased.

These works may only be carried out by qualified personnel.

5.10.7 Wide Range (o)

With the Wide Range Option, chargers can be operated with a supply voltage of 100V and 230V as well.

Note

There is only a limited power range available. Necessarily compare to the indicated input voltage range (refer to "Technical data").

If inappropriate devices are connected to a 100 V supply network, a flawless charging operation is no longer ensured. A destruction of the device is not excluded.

5.10.8 Aquamatik (o)

The "Aquamatik" option of the FILON FUTUR charger is used to trigger an automatic water refilling system. The water refilling system is used for the automatic adjusting of the nominal electrolyte level. The charging gases escape through the degassing opening of the plugs. The valve inside the plug in connection with a floater and float linkage triggers the refill process with regard to the required water amount. The water pressure on the valve shuts the water supply off and ensures safe closing of the valve.

The automatic water refilling system can be triggered in several ways.

Triggering via:

- a potential-free contact
- a 230V AC voltage
- a 12V AC voltage

Note

Connection pressure / falling water

The water refilling system must be operated in such a manner that the water pressure inside the water pipe is between 0.3 to 1.8 bar. The installation height of the storage tank depends on the used water refilling system.

Triggering via:

▶ Immersion pump:

The immersion pump generates the required filling pressure. The storage tank and battery must be placed without difference in height.

▶ Valves without immersion pump:

In order to achieve the necessary filling pressure, the lower edge of the storage tank must be at least 3 cm above the upper edge of the battery.

Operation of the automatic water refilling system

Conditions

- The battery is connected to the automatic "Aquamatik" water refilling system
- The charger is equipped with the "Aquamatik" option
- The charger is connected to the battery
- The charging process has been started

Proceeding

- 10 minutes before the recharge stops, a relay contact for triggering the automatic water refilling system is cyclically triggered in the following interval:
- switched on for 15 seconds -> water supply to the battery opened
- switched off for 5 seconds -> water supply to the battery closed

5.10.9 Cool Down Indication (o)

The CDI display indicates the cooling phase of the battery after the charge. It starts immediately after the ending of the charge and lasts 30 minutes.





The display of the cooling phase is displayed by the constantly lit blue LED and the flashing green LED. If the cooling phase completed, only the green LED lights up.

5.11 Faults and error messages

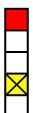

➔ If it is not possible to put the charger back into operation after the following "troubleshooting measures" have been performed or if the LED display indicates a fault and/or defect regarding the electronics, please inform the manufacturer's service department. Further troubleshooting must only be performed by the manufacturer's customer service. The manufacturer provides a customer service which is specially trained for these tasks. The following important and useful information must be provided to the customer service in order to allow a quick and targeted response to the fault:

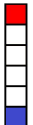
- Serial number of the charger
- Indication shown on LED display
- Error description
- Current location of the charger.

The five LEDs of the operating and display unit indicate faults as well as the state of the charger.

LED display	Description	Error number
	No battery or switched poles Battery voltage <0.5 V/Z	ERROR 1
 x = flashing	Battery voltage too high when switching on the device (> 2.40 V/Z) Characteristic curve set without charging function	ERROR 2
	Pre-charging takes too long (battery voltage < 1.5 V/Z for more than 30 minutes)	ERROR 3
	Constant current phase (I ₁) too long	ERROR 4
	Constant current phase (U ₁) too long	ERROR 5
	Internal ambient temperature exceeds limits T < -20°C or T > 50°C	ERROR 6
	Cooling element or transformer temperature exceeded (only single-phase units)	ERROR 7
	External temperature sensor (battery) exceeds limits Optional	ERROR 8
	Phase failure three-phase current with at least 1 phase available	ERROR 9
	Problem with internal data bus	ERROR 10
	No charging current, although enabled	ERROR 11
	Charging current > 104% nominal value*	ERROR 12
	Charging current > 102% nominal value*	ERROR 13
	Module defective (only Filon Futur XL)	ERROR 14
	reserved	ERROR 15

The following table gives an overview of the possible error causes and respective troubleshooting:

LED	Error	Error description	Troubleshooting measure
	1.	No battery, Battery connected with switched poles, Battery voltage < 0.5 V/Z	Starting point: battery connected Check polarity and correct, if necessary Measure battery voltage: - Battery voltage below 0.5V/Z Increase battery voltage to more than 0.5V using appropriate measures Check output fuse
 x = flashing	2.	Battery voltage too high when switching on the device (> 2.40 V/Z) Characteristic curve set without charging function	Wait for 1 minute after the battery has been connected Check battery assignment - Check the rated voltage data of battery and charger If the rated voltage of the battery is higher than the rated voltage of the charger, the charger is unsuitable If the rated voltage of the battery is lower than the rated voltage of the charger, it is necessary to check if the charger has a suitable characteristic setting Some chargers have a characteristic curve without charging function - In this case it is necessary to check, if a suitable characteristic curve has been set
	3.	Pre-charging takes too long (battery voltage < 1.5 V/Z for more than 30 minutes)	Check battery assignment - Compare the rated voltage and capacity of the battery with the charger settings If there are no matching charging settings for the battery, the charger is unsuitable. Check battery for shorted cells If there are no evident errors, the charger may be restarted Check pre-charge current - If the measured current is significantly lower than the pre-charge current predefined by the characteristic curve, there is an error in the charger. The error occurs again after 30 minutes - Contact the service technician
	4.	Constant current phase takes too long	Check battery assignment - Compare the battery capacity with the charger settings. If there are no matching charging settings for the battery, the charger is unsuitable Check battery - Battery too hot: If a battery fault can be excluded, the charging process may be continued after a sufficient cooling phase. - Battery defective (e. g. shorted cells) - Battery has been deeply discharged: Restart charging process If the error persists, contact the service technician
	5.	Constant current phase takes too long (optional, if specified in characteristic curve table)	Proceed as described in error 4 - Here, a deeply discharged battery can be excluded as error cause.

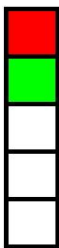
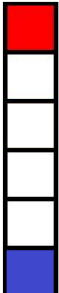
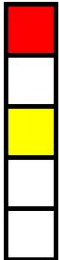
LED	Error	Error description	Troubleshooting measure
	6.	Temperature inside the charger too high	Check air inlet and outlet openings <ul style="list-style-type: none"> - The charger openings must be uncovered. If there are dust filters installed, these have to be cleaned and/or replaced, if necessary. Select the installation room in such a manner that unhindered air exchange is ensured. Keep sufficient distance to other chargers or heat sources.
	7.	Transformer or cooling element temperature too high	Excessively high ambient temperatures might affect the charging operation Check fan function when charging If these causes can be excluded, contact the service technician.
	8.	Battery temperature exceeded (optional)	Check battery <ul style="list-style-type: none"> - If a battery fault can be excluded, the charging process may be continued after a sufficient cooling phase.
	9.	Phase failure	Check power supply <ul style="list-style-type: none"> - Measure at the wall socket whether the supply voltage is properly connected to all phases. If necessary, check the mains fuse in the distribution. Check control board If the error persists, contact the service technician
	10.	Problem with internal data bus	Hardware and control error
	11.	No charging current	<ul style="list-style-type: none"> - Repeat the charging process in order to acknowledge the error. If the error occurs again, contact the service technician
	12.	Charging current > 104% nominal value	
	13.	Charging voltage > 102% nominal value	
	14:	Module defective	Check power module <ul style="list-style-type: none"> - The defective power module is indicated, if chargers are equipped with a display Contact the service technician

5.12 Warnings

Warnings do not cause the interruption of a charging process. They draw the user's attention to the fact that an error exists, which affects the charging process. The following warning can occur:

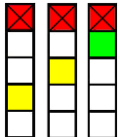
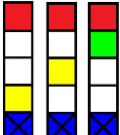
LED	Warning	Device behaviour unchanged	Troubleshooting measure
 <p>The red LED flashes in addition to the charge level indication</p>	<p>Temperature sensor defective or not connected</p>	<p>Monitoring the battery temperature is no longer possible. A battery temperature of 30°C is predefined for the charger.</p>	<p>Check the connection of the temperature sensor</p> <ul style="list-style-type: none"> - Check if there are visible damages and inform the charger manufacturer, if necessary. <p>If the error is eliminated, the red LED switches off and the charging is adjusted to the current battery temperature.</p> <p>If the error persists, contact the service technician.</p>
 <p>The blue LED flashes in addition to the charge level indication</p>	<p>EC pump cannot build up pressure</p>	<p>The charging continues without EC. This prolongs the charging time by up to 3 hours.</p>	<p>Check hose connection</p> <ul style="list-style-type: none"> - Ensure proper connection between air hose and battery. - Check hose for damages and repair, if necessary. <p>If the error persists, contact the service technician.</p>

5.13 Disconnect the charger from the supply network

The charger is supplied via the power cable. Disconnect the charger from the mains, if

- it is not permanently used,
- the charging electronics should be reset (Reset), e. g. if a fault is indicated.

6. Maintenance and repair

6.1 Cleaning, inspection and maintenance

! Warning

Warning of dangerous electrical voltage!

The charger is an electrical device containing voltages and currents which are harmful to humans.

- ▶ The charger may only be operated by qualified personnel that have been instructed and trained.
 - ▶ Disconnect the power supply and, if necessary, the connection to the battery, before opening and working on the charger.
 - ▶ Only qualified electricians may open and repair the charger.
-

! Warning

The general operating conditions of a charger considerably affect the wear and tear of the maintenance components. The stated maintenance intervals apply to normal working conditions.

- ▶ In case of increased requirements (e. g. high dust incidence or strongly fluctuating temperatures), the intervals have to be shortened suitably. In case of doubt, contact the responsible qualified personnel.
-

Note

HF chargers are forced-air cooled by means of a fan. As a result, dust can enter the inside of the chargers. The stated maintenance intervals apply to normal working conditions.

- ▶ The installation room of the charger must be ventilated.
 - ▶ The installation room of the charger must be kept clean.
 - ▶ Check the charger for inner contamination and clean it at least every six months. Only qualified electricians must carry out works inside the charger. .
 - ▶ In case of increased requirements (e. g. high dust incidence or strongly fluctuating temperatures), the intervals have to be shortened suitably. In case of doubt, contact the responsible qualified personnel.
-

Note

If chargers are equipped with an EC pump, the air filter element must be replaced annually. The stated maintenance intervals apply to normal working conditions

- ▶ Replace the air filter element of the EC pump annually. Only qualified electricians may replace the air filter element and carry out works inside the device.
 - ▶ In case of increased requirements (e. g. high dust incidence or strongly fluctuating temperatures), the intervals have to be shortened suitably. In case of doubt, contact the responsible qualified personnel.
-

→ Use a dry cloth to remove dust or dirt from the charger.

Prior to each charging, ensure that:

- the mains connection is undamaged,
- the housing does not show any damages,
- the insulation of the charging and power cables is undamaged,
- the charging plug is undamaged,
- all screw connections are fastened.

! Warning

A damaged or otherwise defective charger may cause accidents

If the charger and/or its performance show safety-relevant modifications, damages or other defects, do not use the charger until it has been properly repaired.

- ▶ Detected defects must be reported to the superior immediately.
 - ▶ The defective charger must be marked and decommissioned.
 - ▶ Do not use the charger until the defect has been localised and rectified.
-

6.2 Spare parts

If you require spare parts, contact the manufacturer or supplier and provide the charger data stated on the type plate.

7. Disposal

If the charger is definitively decommissioned, the applicable laws and regulations regarding disposal are to be observed.

Detailed information can be provided by the specialised waste management companies or competent authorities.

Note

Electronic waste represents a high hazard potential for the environment due to its plastic, metal and heavy metal components.

- ▶ Electronic waste must be disposed of and collected separately from household or commercial waste
- ▶ Supply electronic waste to the internal waste management (if any), which assumes the forwarding to specialised companies (specialised waste management companies).

The packaging of the charger must be disposed of separately. Paper, cardboard and plastics must be recycled.

8. Appendix

8.1 Dimension and section drawing

Housing	Dimensions		
	Height	Width	Depth
HF450	115	430	256

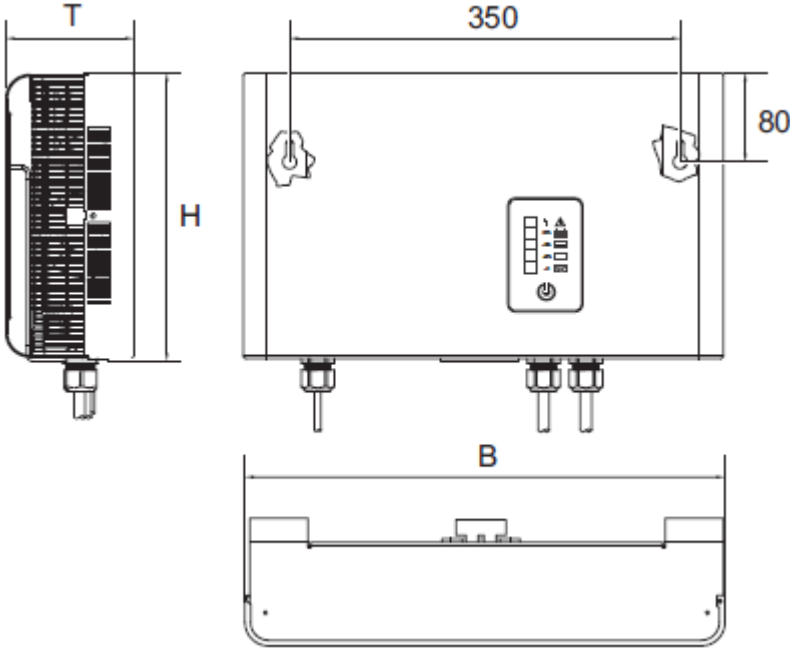

Housing	Dimensions		
	Height	Width	Depth
HF450 EU	115	610	256

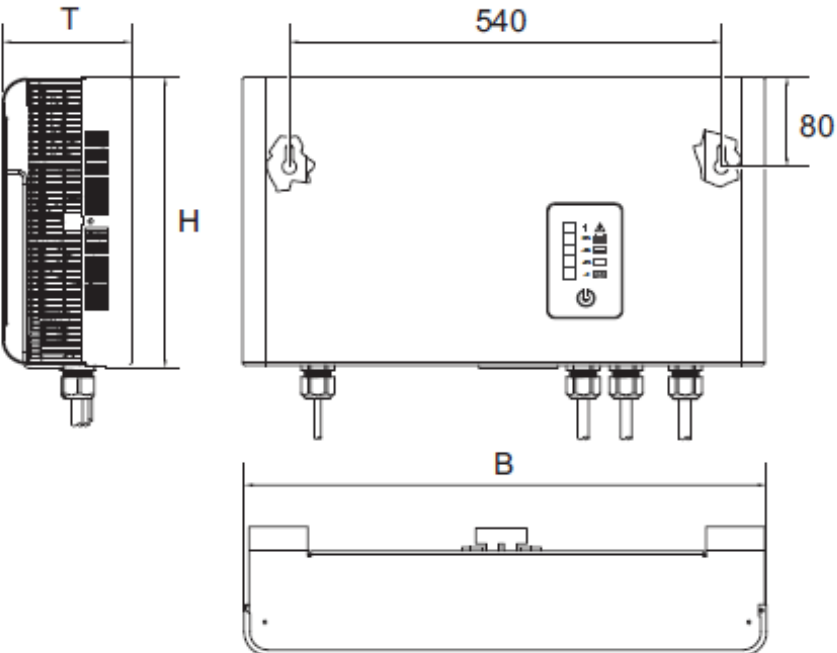

Housing	Dimensions		
	Height	Width	Depth
HF550	395	430	300
HF650	695	430	300
HF750	790	430	300

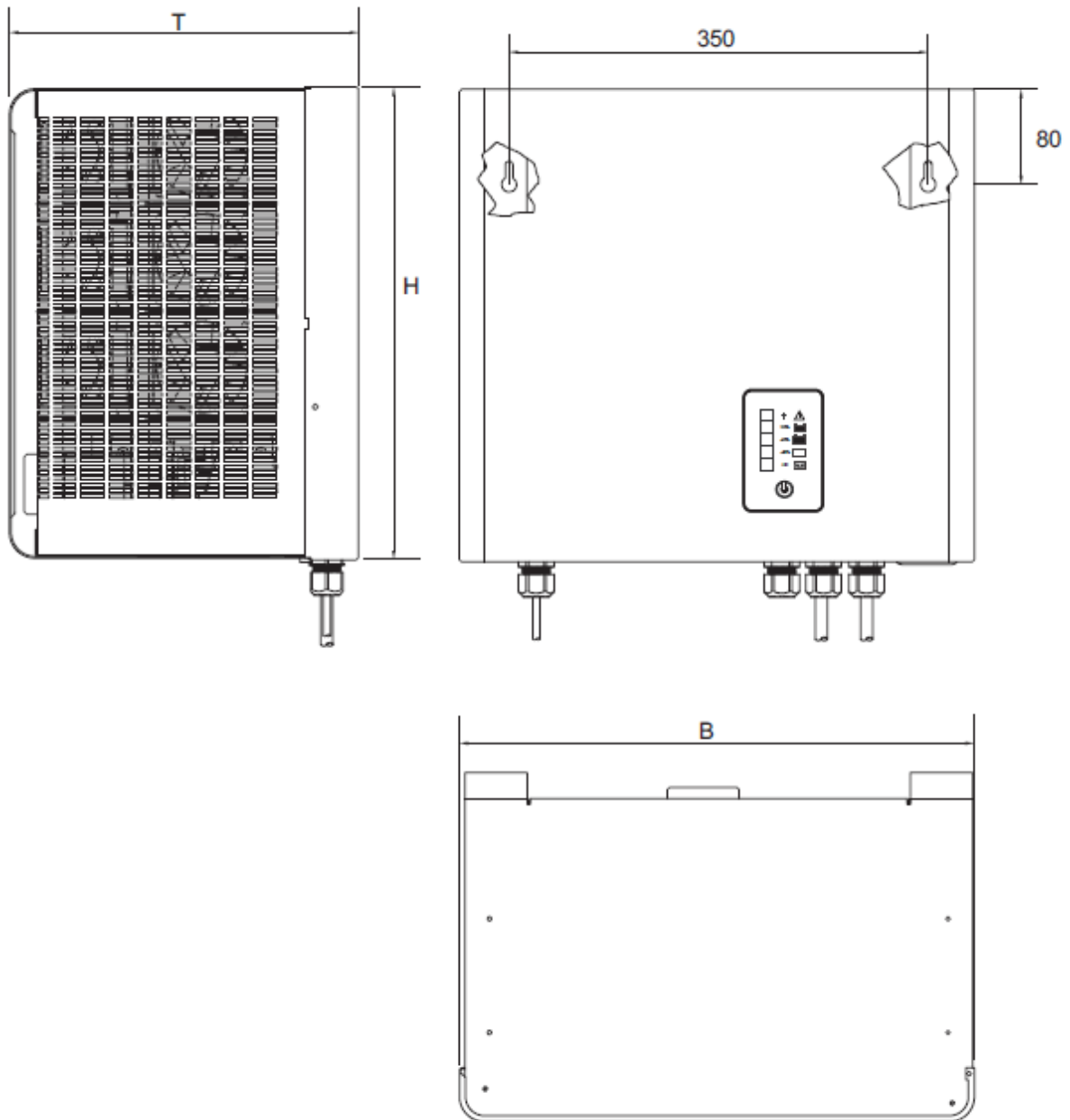

9. Technical data - Standards

Device series	FILON FUTUR
Device no.	see type plate
Charging characteristic	see technical data
Temperature range	0 - 40°C
Rated input frequency	47 – 63Hz
Protection class	see technical data
Housing	see dimension and section drawing
Standards	<p>2006/95/EC – Low Voltage Directive</p> <p>2004/108/EEC – EMC directive</p> <p>EN 60335-1 – Safety of household and similar electrical appliances</p> <p>EN 60335-2-29 – Safety of household and similar electrical appliances - Particular requirements for battery chargers</p> <p>EN 61558 – Transformers</p> <p>EN 60146 – Semiconductor converters</p> <p>EN 61000-6-2 and EN 61000-6-3 – EMC</p> <p>EN 61000-3-2 – Circuit feedback</p> <p>EN 61000-3-3 – Voltage fluctuations and flicker</p> <p>EN 61000-4-2 – ESD</p> <p>EN 61000-4-3 – Influence of electromagnetic fields</p> <p>EN 61000-4-4 – Burst</p> <p>EN 61000-4-5 – Surge</p> <p>EN 61000-4-6 – Conducted interferences induced by HF fields</p> <p>EN 61000-4-11 – Voltage dips, short interruptions and voltage variations immunity</p> <p>EN 60068-2-6 – Vibration sinusoidal</p> <p>EN 60068-2-27 – Semi-sinusoidal shock</p> <p>DIN VDE 0701/0702 – Inspection of electrical appliances</p> <p>EN50178 – Equipment of power installations with electrical components</p>

**Industrie
Elektronik
Brilon GmbH**

**Almerfeldweg 40
59929 Brilon, Germany**

**Ph.: +49 (0)2961/9607-0
Fax: +49 (0)2961/9607-77**

www.ieb.de – info@ieb.de

